







Cable Glands for Non-armoured Cables

E-OCTANS

Technical Details	
Material	Body, Cap Brass, Brass Nickel Plated, Stainless Steel 316L, Aluminium Seal CR (Chloroprene), Silicone O-ring CR (Chloroprene), Silicone
Ingress Protection Rating	IP 68 - 5 Bar, 30 min IP 66
Operating Temperature	Seal Material CR (Chloroprene) -40°C to +80°C Silicone -60°C to +80°C
Ex d/tb	-40°C to +80°C
Ex e/tb	-40°C to +80°C
Equipment For	Gas & Dust potentially explosive atmospheres
Suitable for use in	Group II Gas Group IIC ZONE1/ZONE2 Group III Dust Group IIIC ZONE21/ZONE 22
Equipment Marking	Ex II 2GD Ex db IIC Gb Ex eb IIC Gb Ex tb IIIC Db
Marking Example *	BMD EBU.. CE 0722  II 2GD Ex db IIC Gb Ex eb IIC Gb Ex tb IIIC Db Ta-40°C to +80°C IP66/68 IECEx CES 13.0006X CESI 13 ATEX 018X
Thread Type	• Metric (M) ISO Pitch 1,5 • NPT (N) ANSI ASME B1.20.1 • Other thread types also available upon request.
Cable Type	Non Armoured
Accessories	• Lock nuts • Gaskets (Washers) • Serrated Washers • Shrouds • Earth tags • Dome plugs
Remarks	• Accessories must be ordered separately. • O-ring available in Metric outer threads.
Approvals	Certificate Number Standards
	IMQ 13 ATEX 018X EN 60079-0 EN 60079-7 EN 60079-31 EN 60079-1
	IECEx IMQ 13.0006X IEC 60079-0 IEC 60079-7 IEC 60079-31 IEC 60079-1
	20150501-E474828 UL 2225, CAN/CSA-C22.2 No. 60079-0:11 CAN/CSA C22.2 No. 60079-7:12 CAN/CSA-C22.2 No. 60079-31:12
	№ TC RU C-TR.AA87.B.00941 ГОСТ 31610.0 ГОСТ IEC 60079-1 ГОСТ IEC 60079-31
	DNV 12.0052 X ABNT NBR IEC 60079-0 ABNT NBR IEC 60079-1 ABNT NBR IEC 60079-7 ABNT NBR IEC 60079-31
	TAE00003WU IEC/EN60079-0 IEC/EN60079-7 IEC/EN60079-31 IEC/EN60079-1 IEC/EN 62444

-For more information see our webpage.
* The standard marking consists ATEX & IECEx only. Marking acc. to other standards on request.



Order Coding									
Part Number	Material	Seal	Gasket (Washer)	Seal Plug	Serrated Washer	Lock Nut	Shroud	Earth Tag	for Ex e
Mandatory	Mandatory	Mandatory	- Option	Option	Option	Option	Option	Option	Option
See table	B Brass BN Brass Nickel plated X Stainless Steel 316L A Aluminium	C Chloroprene S Silicone	- WC Chloroprene WS Silicone WF Fiber	P Dome Plug	WSR Serrated washer	L Lock nut	S Shroud	E Earth tag	TL9
Example									
EBU1N (*BUE)	BN	S	- WC	P	WSR	L	S	E	TL9

* BUE: Part Number is valid for Customs Union certificate.

E-OCTANS

Cable Glands for Non-armoured Cables

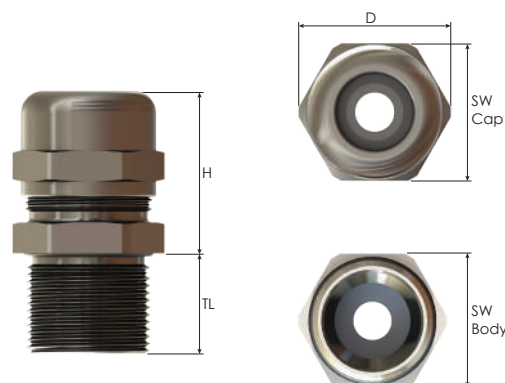







Thread Type **METRIC** acc. to ISO 965 - 3

Outer Thread Size (Male)	Clamping Range		Outer Thread Length		Spanner Width		Outer Ø	max. Height	Part Number
	Ø min - max mm	Seal Type	Ex-e min.	Ex-d/e min.	Cap	Body			
			TL mm		SW Cap mm	SW Body mm	D mm	H mm	
M12x1,5	3,0 - 8,0	Double	9,0	16,0	20	20	22,0	29,0	EBU0M
	4,0 - 8,0	Triple	9,0	16,0	22	22	24,5	33,0	EBU0SM
M16x1,5	3,0 - 9,0	Double	9,0	16,0	20	20	22,0	29,0	EBU01SM
	4,0 - 12,0	Triple	9,0	16,0	22	22	24,5	33,0	EBU01M
M20x1,5	3,0 - 9,0	Double	9,0	16,0	20	22	24,5	29,0	EBU1SM
	4,0 - 12,0	Triple	9,0	16,0	22	22	24,5	29,0	EBU1M
	10,0 - 16,0	Triple	9,0	16,0	28	28	31,0	32,0	EBU12M
M25x1,5	4,0 - 12,0	Triple	9,0	16,0	22	28	31,0	29,0	EBU2SM
	10,0 - 18,0	Triple	9,0	16,0	28	28	31,0	32,5	EBU2M
	14,0 - 20,0	Triple	9,0	16,0	35	35	39,0	36,0	EBU23M
M32x1,5	10,0 - 18,0	Triple	9,0	16,0	28	35	39,0	32,5	EBU3SM
	14,0 - 24,0	Triple	9,0	16,0	35	35	39,0	35,0	EBU3M
	22,0 - 28,0	Triple	9,0	16,0	45	45	49,5	42,5	EBU34M
M40x1,5	14,0 - 24,0	Triple	9,0	18,0	35	45	49,5	35,0	EBU4SM
	22,0 - 32,0	Triple	9,0	18,0	45	45	49,5	42,5	EBU4M
	26,0 - 34,0	Triple	9,0	18,0	50	50	56,0	45,5	EBU45M
M50x1,5	22,0 - 32,0	Triple	9,0	18,0	45	55	61,0	42,5	EBU5SM
	26,0 - 35,0	Triple	9,0	18,0	50	55	61,0	45,5	EBU5M
	35,0 - 44,0	Triple	9,0	18,0	64	64	70,0	45,0	EBU56M
M63x1,5	26,0 - 35,0	Triple	9,0	18,0	50	68	75,0	45,5	EBU6SM
	35,0 - 45,0	Triple	9,0	18,0	64	68	75,0	45,0	EBU6M
	46,0 - 56,0	Triple	9,0	18,0	80	75	89,0	54,0	EBU67M
M75x1,5	35,0 - 45,0	Triple	9,0	20,0	64	80	89,0	45,0	EBU7SM
	46,0 - 62,0	Triple	9,0	20,0	80	80	89,0	54,0	EBU7M
	60,0 - 69,0	Triple	9,0	20,0	95	95	105,0	57,0	EBU78M
M90x1,5	46,0 - 62,0	Triple	9,0	20,0	80	95	105,0	53,5	EBU8SM
	60,0 - 75,0	Triple	9,0	20,0	95	95	105,0	57,0	EBU8M
	75,0 - 82,0	Triple	9,0	20,0	105	105	117,0	56,0	EBU810M
M100x1,5	60,0 - 75,0	Triple	9,0	20,0	95	105	117,0	57,0	EBU10SM
	75,0 - 85,0	Triple	9,0	20,0	105	105	117,0	56,0	EBU10M
M110x1,5	85,0 - 95,0	Triple	9,0	20,0	115	115	128,0	58,0	EBU11M
M115x2,0	75,0 - 85,0	Triple	9,0	24,0	105	130	144,0	56,0	EBU115XSM
	85,0 - 95,0	Triple	9,0	24,0	115	130	144,0	58,0	EBU115SM
	95,0 - 105,0	Triple	9,0	24,0	130	130	144,0	64,5	EBU115M
M130x2,0	105,0 - 115,0	Triple	9,0	24,0	140	140	154,0	67,5	EBU13M

Cable Glands for Non-armoured Cables

E-OCTANS

Technical Details	
Material	Body, Cap Brass, Brass Nickel Plated, Stainless Steel 316L, Aluminium Seal CR (Chloroprene), Silicone O-ring CR (Chloroprene), Silicone
Ingress Protection Rating	IP 68 - 5 Bar, 30 min IP 66
Operating Temperature	Seal Material CR (Chloroprene) -40°C to +80°C Silicone -60°C to +140°C
Equipment For	Gas & Dust potentially explosive atmospheres
Suitable for use in	Group II Gas Group IIC ZONE1/ZONE2 Group III Dust Group IIIC ZONE21/ZONE 22
Equipment Marking	Ex II 2GD Ex db IIC Gb Ex eb IIC Gb Ex tb IIIC Db
Marking Example *	BMD EBU.. CE 0722  II 2GD Ex db IIC Gb Ex eb IIC Gb Ex tb IIIC Db Ta-40°C to +80°C IP66/68 IECEx CES 13.0006X CESI 13 ATEX 018X
Thread Type	• Metric (M) ISO Pitch 1,5 • NPT (N) ANSI ASME B1.20.1 • Other thread types also available upon request.
Cable Type	Non Armoured
Accessories	• Lock nuts • Gaskets (Washers) • Serrated Washers • Shrouds • Earth tags • Dome plugs
Remarks	• Accessories must be ordered separately. • O-ring available in Metric outer threads.
Approvals	Certificate Number Standards
	IMQ 13 ATEX 018X EN 60079-0 EN 60079-7 EN 60079-31 EN 60079-1
	IECEx IMQ 13.0006X IEC 60079-0 IEC 60079-7 IEC 60079-31 IEC 60079-1
	20150501-E474828 UL 2225, CAN/CSA-C22.2 No. 60079-0:11 CAN/CSA C22.2 No. 60079-7:12 CAN/CSA-C22.2 No. 60079-31:12
	20161226-E199260 UL 514B UL50E
	№ TC RU C-TR.AA87.B.00941 GOCT 31610.0 GOCT IEC 60079-1 GOCT IEC 60079-31
	DNV 12.0052 X ABNT NBR IEC 60079-0 ABNT NBR IEC 60079-1 ABNT NBR IEC 60079-7 ABNT NBR IEC 60079-31
	TAE00003WU IEC/EN60079-0 IEC/EN60079-7 IEC/EN60079-31 IEC/EN60079-1 IEC/EN 62444

-For more information see our webpage.

* The standard marking consists ATEX & IECEx only. Marking acc. to other standards on request.



Order Coding								
Part Number	Material	Seal	Gasket (Washer)	Seal Plug	Serrated Washer	Lock Nut	Shroud	Earth Tag
Mandatory	Mandatory	Mandatory	- Option	Option	Option	Option	Option	Option
See table	B Brass BN Brass Nickel plated X Stainless Steel 316L A Aluminium	C Chloroprene S Silicone	- WC Chloroprene WS Silicone WF Fiber	P Dome Plug	WSR Serrated washer	L Lock nut	S Shroud	E Earth tag
Example	EBU1N (*BUE) BN	S	- WC	P	WSR	L	S	E

* BUE: Part Number is valid for Customs Union certificate.

E-OCTANS

Cable Glands for Non-armoured Cables

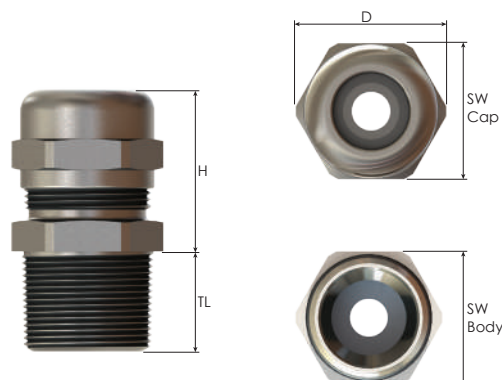

Thread Type **NPT** acc. to ANSI ASME B1.20.1

Outer Thread Size (Male)	Clamping Range		Outer Thread Length TL mm	Spanner Width		Outer Ø D mm	max. Height H mm	Part Number
	Ø min - max mm	Seal Type		SW Cap mm	SW Body mm			
NPT 1/4"	3,0 - 8,0	Double	16	20	20	22,0	29,0	EBU0N
	4,0 - 8,0	Triple	16	22	22	24,5	33,0	EBU0SN
NPT 3/8"	3,0 - 9,0	Double	16	20	20	22,0	29,0	EBU01SN
	4,0 - 12,0	Triple	16	22	22	24,5	33,0	EBU01N
NPT 1/2"	3,0 - 9,0	Double	16	20	22	24,5	29,0	EBU1SN
	4,0 - 12,0	Triple	16	22	22	24,5	29,0	EBU1N
	10,0 - 16,0	Triple	16	28	28	31,0	32,0	EBU12N
NPT 3/4"	4,0 - 12,0	Triple	16	22	28	31,0	29,0	EBU2SN
	10,0 - 18,0	Triple	16	28	28	31,0	32,0	EBU2N
	14,0 - 20,0	Triple	16	35	35	39,0	35,0	EBU23N
NPT 1"	10,0 - 18,0	Triple	20	28	35	39,0	32,5	EBU3SN
	14,0 - 24,0	Triple	20	35	35	39,0	35,0	EBU3N
	22,0 - 26,0	Triple	20	45	45	49,5	42,0	EBU34N
NPT 1 1/4"	14,0 - 24,0	Triple	20	35	45	49,5	35,0	EBU4SN
	22,0 - 32,0	Triple	20	45	45	49,5	42,5	EBU4N
	26,0 - 34,0	Triple	20	50	50	56,0	45,5	EBU45N
NPT 1 1/2"	22,0 - 32,0	Triple	20	45	55	61,0	42,5	EBU5SN
	26,0 - 35,0	Triple	20	50	55	61,0	45,5	EBU5N
	35,0 - 41,0	Triple	20	64	64	70,0	44,0	EBU56N
NPT 2"	26,0 - 35,0	Triple	20	50	68	75,0	45,5	EBU6SN
	35,0 - 45,0	Triple	20	64	68	75,0	45,0	EBU6N
	46,0 - 52,0	Triple	20	80	75	89,0	54,0	EBU67N
NPT 2 1/2"	35,0 - 45,0	Triple	21	64	80	89,0	45,0	EBU7SN
	46,0 - 62,0	Triple	21	80	80	89,0	53,5	EBU7N
	60,0 - 64,0	Triple	21	95	95	105,0	57,0	EBU78N
NPT 3"	46,0 - 62,0	Triple	21	80	95	105,0	53,5	EBU8SN
	60,0 - 75,0	Triple	21	95	95	105,0	57,0	EBU8N
	75,0 - 79,5	Triple	21	105	105	117,0	56,0	EBU810N
NPT 4"	60,0 - 75,0	Triple	21	95	115	128,0	57,0	EBU108N
	75,0 - 85,0	Triple	21	105	115	128,0	56,0	EBU10N
	85,0 - 95,0	Triple	21	115	115	128,0	58,0	EBU11N
	95,0 - 101,0	Triple	21	130	130	144,0	64,5	EBU115N
NPT 5"	95,0 - 105,0	Triple	27	130	145	162,0	64,5	EBU13N
	105,0 - 115,0	Triple	27	140	145	162,0	67,5	EBU130N